

# Wardrobe HPL lockers

The Malow Company has a pleasure to introduce to you a new offer- HPL lockers. These HPL lockers are made from the best high pressure laminate. You will find social rockers in our offer.



Waterproof HPL lockers are ideal in :

- the sports facilities:
  - pools,
  - swimming pools,
  - icerinks,
  - sports hall,
  
- the recreational facilities:
  - gyms,
  - fitness clubs,
  - squash clubs,
  
- the workplaces – industrial safety (CT) lockers

Advantages of HPL lockers are:

- resistance to moisture
- surface hardness
- UV resistance
- resistance to chemicals and biological substances
- durability
- easy to keep clean

Two types of lockers available :

- **HPL laminated module lockers based on aluminium profile construction.** Door, shelf, the bottom , the top are made from 10mm laminate. Back wall, side and middle wall are made from 4mm laminate. Lockers are made according to the room's design. During the assembly they are arranged into any number of sequences.



- **These lockers are made from the HPL laminated coat.** Door, side wall, shelf, the bottom , the top are made from the 10mm laminate, the back wall is made from the 4 mm laminate.

Each of the locker is available in 2 versions :



**The base with bench**

410 mm-height of the bench  
Feet are adjustable to the height of -30 mm



**On legs**

100 mm- height of the legs  
Feet are adjustable to the height of -30 mm



SUL , SUS lockers have in standard :  
- hanger



SUM lockers have in standard :  
- bar  
-hook



Corrosion resistant hinges



Mechanical Eurolock  
Optionally: door numbering

**Available colours:**

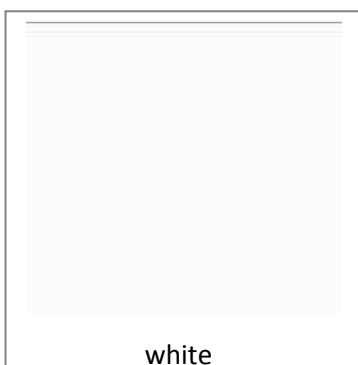

white

K1040 – white ALPINO

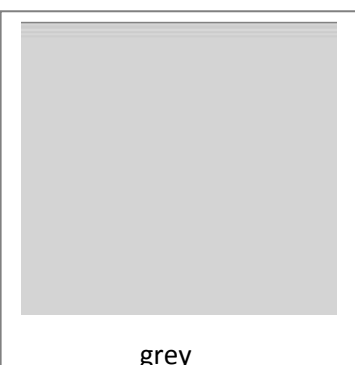

grey

F7927 – gray FOLKESTONE

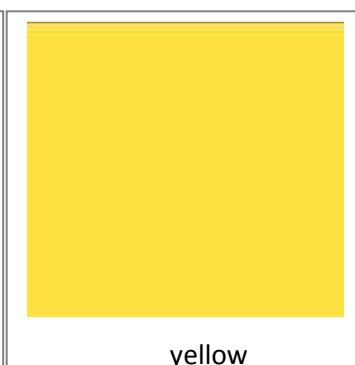

yellow

F1485 – yellow CHROME YELLOW

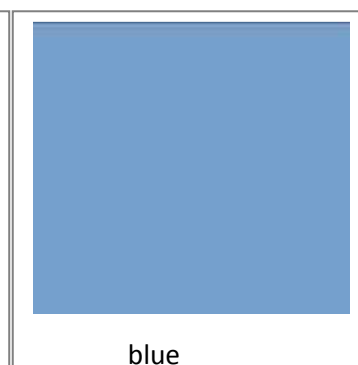





blue

K1019 – blue AZUR



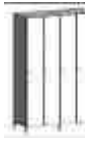

Also an armband with a key





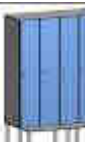

### The SUM lockers based on aluminium profiles – on legs

|                   |   |   |   |  |   |  |
|-------------------|---|---|---|--|---|--|
|                   |  |  |  |  |  |  |
| Description       |   |   |   |  |   |  |
| Code              |   |   |   |  |   |  |
| Height (mm)       | 1900  |   | 1900  |  | 1900  |  |
| Width (mm)        | 611   811   | 905,50   1205,50  | 1200   1600   | 1494,50   1894,50  | 1789  |  |
| Depth (mm)        | 500   |   | 500   |  | 500   |  |
| Segments quantity | 2   |   | 3   |  | 4   |  |
| Legs option       | +   |   | +   |  | +   |  |



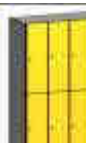

### The SUM lockers based on aluminium profiles – on bases

|                   |   |   |   |  |   |  |
|-------------------|---|---|---|--|---|--|
|                   |  |  |  |  |  |  |
| Description       |   |   |   |  |   |  |
| Code              |   |   |   |  |   |  |
| Height (mm)       | 1900  |   | 1900  |  | 1900  |  |
| Width (mm)        | 611   811   | 905,50   1205,50  | 1200   1600   | 1494,50   1894,50  | 1789  |  |
| Depth (mm)        | 500   |   | 500   |  | 500   |  |
| Segments quantity | 2   |   | 3   |  | 4   |  |
| Bases             | +   |   | +   |  | +   |  |

### The Sus lockers based on aluminium profiles – on legs

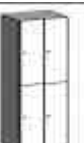
|                   |   |   |   |  |   |  |
|-------------------|---|---|---|--|---|--|
|                   |  |  |  |  |  |  |
| Description       |   |   |   |  |   |  |
| Code              |   |   |   |  |   |  |
| Height (mm)       | 1900  |   | 1900  |  | 1900  |  |
| Width (mm)        | 611   811   | 905,50   1205,50  | 1200   1600   | 1494,50   1894,50  | 1789  |  |
| Depth (mm)        | 500   |   | 500   |  | 500   |  |
| Segments quantity | 2   |   | 3   |  | 4   |  |
| Legs              | +   |   | +   |  | +   |  |

### The SUS lockers based on aluminium profiles – on bases

|             |   |   |   |  |   |  |
|-------------|---|---|---|--|---|--|
|             |  |  |  |  |  |  |
| Description |   |   |   |  |   |  |
| Code        |   |   |   |  |   |  |
| Height (mm) | 1900  |   | 1900  |  | 1900  |  |

|                   |     |     |        |         |      |      |         |         |      |
|-------------------|-----|-----|--------|---------|------|------|---------|---------|------|
| Width (mm)        | 611 | 811 | 905,50 | 1205,50 | 1200 | 1600 | 1494,50 | 1894,50 | 1789 |
| Depth (mm)        | 500 |     | 500    |         | 500  |      | 500     |         | 500  |
| Segments quantity | 2   |     | 3      |         | 4    |      | 5       |         | 6    |
| Bases             | +   |     | +      |         | +    |      | +       |         | +    |

### The Sul lockers based on aluminium profiles – on legs



|                   |      |     |        |         |      |      |         |         |      |
|-------------------|------|-----|--------|---------|------|------|---------|---------|------|
| Description       |      |     |        |         |      |      |         |         |      |
| Code              |      |     |        |         |      |      |         |         |      |
| Height (mm)       | 1900 |     | 1900   |         | 1900 |      | 1900    |         | 1900 |
| Width (mm)        | 611  | 811 | 905,50 | 1205,50 | 1200 | 1600 | 1494,50 | 1894,50 | 1789 |
| Depth (mm)        | 500  |     | 500    |         | 500  |      | 500     |         | 500  |
| Segments quantity | 2    |     | 3      |         | 4    |      | 5       |         | 6    |
| Legs              | +    |     | +      |         | +    |      | +       |         | +    |

### The Sul lockers based on aluminium profiles – on bases

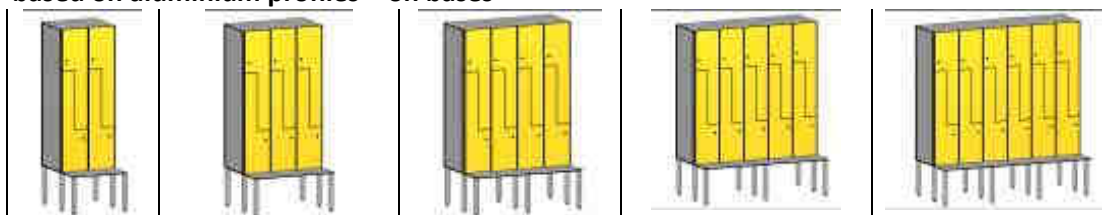





|                   |      |     |        |         |      |      |         |         |      |
|-------------------|------|-----|--------|---------|------|------|---------|---------|------|
| Description       |      |     |        |         |      |      |         |         |      |
| Code              |      |     |        |         |      |      |         |         |      |
| Height(mm)        | 1900 |     | 1900   |         | 1900 |      | 1900    |         | 1900 |
| Width(mm)         | 611  | 811 | 905,50 | 1205,50 | 1200 | 1600 | 1494,50 | 1894,50 | 1789 |
| Depth(mm)         | 500  |     | 500    |         | 500  |      | 500     |         | 500  |
| Segments quantity | 2    |     | 3      |         | 4    |      | 5       |         | 6    |
| Base              | +    |     | +      |         | +    |      | +       |         | +    |

### Fixed HPL laminated Sum lockers – on legs







|                   |      |     |        |         |      |      |         |         |      |
|-------------------|------|-----|--------|---------|------|------|---------|---------|------|
| Description       |      |     |        |         |      |      |         |         |      |
| Code              |      |     |        |         |      |      |         |         |      |
| Height(mm)        | 1900 |     | 1900   |         | 1900 |      | 1900    |         | 1900 |
| Width(mm)         | 605  | 805 | 902,50 | 1202,50 | 1200 | 1600 | 1497,50 | 1997,50 | 1795 |
| Depth(mm)         | 500  |     | 500    |         | 500  |      | 500     |         | 500  |
| Segments quantity | 2    |     | 3      |         | 4    |      | 5       |         | 6    |
| Legs              | +    |     | +      |         | +    |      | +       |         | +    |



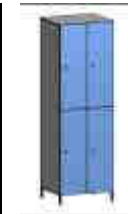
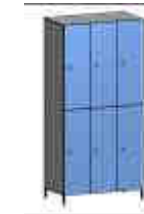

### Fixed HPL laminated Sum lockers – on bases

|                   |   |   |   |  |   |
|-------------------|---|---|---|--|---|
|                   |  |  |  |  |  |
| Description       |   |   |   |  |   |
| Code              |   |   |   |  |   |
| Height(mm)        | 1900  | 1900  | 1900  | 1900   | 1900  |
| width(mm)         | 605   805   | 902,50   1202,50  | 1200   1600   | 1497,50   1997,50  | 1795  |
| Depth(mm)         | 500   | 500   | 500   | 500  | 500   |
| Segments quantity | 2   | 3   | 4   | 5  | 6   |
| Base              | +   | +   | +   | +  | +   |

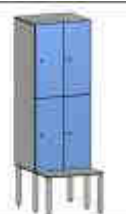

### Fixed HPL laminated Sus lockers – on legs

|                   |   |   |   |  |   |
|-------------------|---|---|---|--|---|
|                   |  |  |  |  |  |
| Description       |   |   |   |  |   |
| Code              |   |   |   |  |   |
| Height(mm)        | 1900  | 1900  | 1900  | 1900   | 1900  |
| Width(mm)         | 605   805   | 902,50   1202,50  | 1200   1600   | 1497,50   1997,50  | 1795  |
| Depth(mm)         | 500   | 500   | 500   | 500  | 500   |
| Segments quantity | 2   | 3   | 4   | 5  | 6   |
| Legs              | +   | +   | +   | +  | +   |

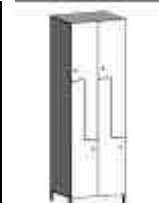
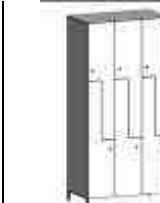

### Fixed HPL laminated Sus lockers – on bases

|                   |   |   |   |  |   |
|-------------------|---|---|---|--|---|
|                   |  |  |  |  |  |
| Description       |   |   |   |  |   |
| Code              |   |   |   |  |   |
| Height(mm)        | 1900  | 1900  | 1900  | 1900   | 1900  |
| width(mm)         | 605   805   | 902,50   1202,50  | 1200   1600   | 1497,50   1997,50  | 1795  |
| Depth(mm)         | 500   | 500   | 500   | 500  | 500   |
| Segments quantity | 2   | 3   | 4   | 5  | 6   |
| Base              | +   | +   | +   | +  | +   |

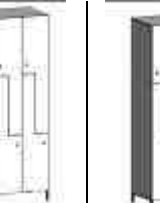
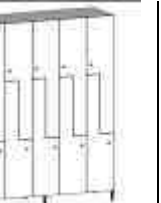
### Fixed HPL laminated Sul lockers – on legs

|                   |   |   |   |   |  |      |
|-------------------|---|---|---|---|--|------|
|                   |  |  |  |  |  |      |
| Description       |   |   |   |   |  |      |
| Code              |   |   |   |   |  |      |
| Height(mm)        | 1900  |   | 1900  |   | 1900   |      |
| Width(mm)         | 605   | 805   | 902,50  | 1202,50   | 1200   | 1600 |
| Depth(mm)         | 500   |   | 500   |   | 500  |      |
| Segments quantity | 2   |   | 3   |   | 4  |      |
| Legs              | +   |   | +   |   | +  |      |

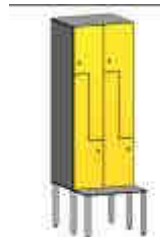
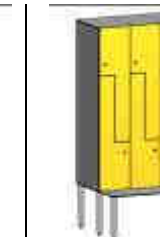
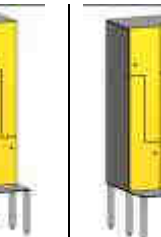
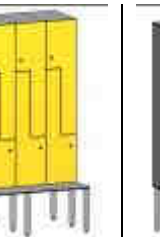
### Fixed HPL laminated Sul lockers– on bases

|                   |  |  |  |  |   |      |
|-------------------|--|--|--|--|---|------|
|                   |  |  |  |  |  |      |
| Description       |  |  |  |  |   |      |
| Code              |  |  |  |  |   |      |
| Height (mm)       | 1900   |  | 1900   |  | 1900  |      |
| Width(mm)         | 605  | 805  | 902,50   | 1202,50  | 1200  | 1600 |
| Depth(mm)         | 500  |  | 500  |  | 500   |      |
| Segments quantity | 2  |  | 3  |  | 4   |      |
| Base              | +  |  | +  |  | +   |      |